



PCE Americas Inc.
711 Commerce Way
Suite 8
Jupiter
FL-33458
USA
From outside US: +1
Tel: (561) 320-9162
Fax: (561) 320-9176
info@pce-americas.com

PCE Instruments UK Ltd.
Units 12/13
Southpoint Business Park
Ensign way
Hampshire / Southampton
United Kingdom, SO31 4RF
From outside UK: +44
Tel: (0) 2380 98703 0
Fax: (0) 2380 98703 9
info@pce-instruments.com

www.pce-instruments.com/english
www.pce-instruments.com

Manual

Shore-Durometer

PCE-DDA 10

PCE-DDD 10

PCE-DDO 10



Version 1.0
Date of creation: 04.08.2015
Date of last change: 27.09.2017

Contents

1	Delivery content	3
2	Introduction	4
3	Safety notes	4
4	Specification	5
4.1	Application fields	5
4.2	Applications	5
4.3	General technical data	5
5	System description	6
5.1	Basic part	6
5.2	Keyboard	6
5.2.1	Power/Return	6
5.2.2	OK	6
5.2.3	UP	6
5.2.4	Down	6
5.3	Interface	6
6	Measuring	7
6.1	Specimen	7
6.2	Measure	7
7	Menu	8
7.1	Menu structure	8
7.2	Menus operation	8
7.3	Calibration	9
7.4	Test setup	9
7.4.1	Test Mode	9
7.4.2	Test Times	9
7.4.3	Tolerance	10
7.4.4	Grubbs error	10
7.4.5	Workpiece	10
7.4.6	Dwell Time	10
7.5	System Setup	10
7.5.1	Date/Time	10
7.5.2	Backlight Time	11
7.5.3	Key Sound	11
7.5.4	Alarm Sound	11
7.6	Memory	11
7.6.1	Browse A to Z	11
7.6.2	Browse Z to A	11
7.6.3	Delete Select	11
7.6.4	Delete All	11
8	Maintain	12
8.1	Generally	12
8.2	Recharging	12
8.3	Reset	12
9	Software	12
9.1	Installation	12
9.2	File upload	12

9.3	Query and search	14
9.4	Delete data	14
9.5	Print	15
9.6	Data export	15
9.7	Close software	15
10	Contact	16
10.1	PCE Instruments UK	16
10.2	PCE Americas	16

1 Delivery content

- rubber hardness tester
- standard calibration plate
- user manual
- Mini USB cable
- charger / AC adaptor
- storage box

The software can be downloaded here: https://www.pce-instruments.com/english/download-win_4.htm.

2 Introduction

Thank you for purchasing a durometer of the PCE-DD series from PCE Instruments.

The durometers are mainly used to measure the hardness of hard rubber and hard plastic, such as: thermoplastic, hard resin, flooring, bowling and especially for on-site hardness measurement of rubber and plastic products.

The principle used to measure hardness is based on measuring the resistance force of the penetration of an indenter into the test material. Penetration (max. 2,5 mm) can be converted to hardness reading on a scale with 100 units. The formula is $HD=100-(L/0,025)$. According to this formula, the types Shore hardness is relative to the displacement of the pressed indenter. Through measuring the displacement of the pressed indenter, the types Shore Hardness can be calculated.

3 Safety notes

Please read this manual carefully and completely before you use the device for the first time. The device may only be used by qualified personnel and repaired by PCE Instruments personnel. There is no warranty of damages or injuries caused by non-observance of the manual.

Only authorized charger is allowed to be applied to this, otherwise it will be damaged permanently.

Any part of this can't be immersed in water or be exposed to rain, otherwise it will be damaged permanently

Origin package is needed for long time storage.

Temperature: -30 ... +80 °C / Relative Humidity: 5 ... 95 % RH

The Battery should be charged fully before first using

The device may only be used in approved temperature range

The opening of the case should only be done by qualified personnel of the PCE Instruments.

The instrument should never be placed with the user interface (e.g. keyboard side) on a table

You should not make technical changes on the device

The appliance should only be cleaned with a damp cloth / use only pH-neutral cleaner

This user's handbook is published from PCE Instruments without any guarantee.

We expressly point to our general guarantee terms, they can be found in our general terms of business.

If you have any questions please contact PCE Instruments.

4 Specification

4.1 Application fields

	A/C	B/D	o/do/oo
Strut diameter of the indenter (mm)	2,25 ±0,1	1,25 ±0,1	2,38 ±0,08
Top plane diameter of the indenter (mm)	0,79 ±0,03	-	-
Top sphere radius (mm)	-	0,1 ±0,01	1,19 ±0,05
Top cone angle of the indenter	(35 ±0,25)°	(30 ±0,5)°	-

4.2 Applications

TYPE	Applications
A	Soft vulcanized rubber, natural rubber, nitriles, thermoplastic elastomers, flexible polyacrylics and thermosets, wax, felt and leathers
C	Medium-hard rubber, thermoplastic elastomers, medium-hard plastics and thermoplastics
D	Hard rubber, thermoplastic elastomers, harder plastics and rigid thermoplastics
B	Moderately hard rubber, thermoplastic elastomers, paper products and fibrous materials
OO	Soft rubber, thermoplastic elastomers, very soft plastics and thermoplastics, medium-density textile windings
O	Extremely soft rubber, thermoplastic elastomers, sponge, extremely soft plastics and thermoplastics, foams, low-density textile windings, human and animal tissue
DO	Moderately hard rubber, thermoplastic elastomers and very dense textile windings

4.3 General technical data

Measure Range	0 ... 100 H
Measure accuracy	≤ ±1 H
Data memory	500 readings
Power	3,6 V rechargeable Ni-MH battery
Working time	About 20 hrs (by one recharging)
Recharging time	About 3 hours
Work temperature	0 ... +50 °C
Work humidity	20% ... 85 % RH
Storage	-30 ... +80 °C / 5 ... 95 % RH
Dimensions	153 x 50 x 29 mm (main body)
Weight	Approx. 170 g
Conforms to	GB/T 531.1, ISO7619-1, ASTM D 2240

5 System description

5.1 Basic part

Digital Durometer Main body: 1 x

Charger: 1 x

Standardized thickness block: 1 x

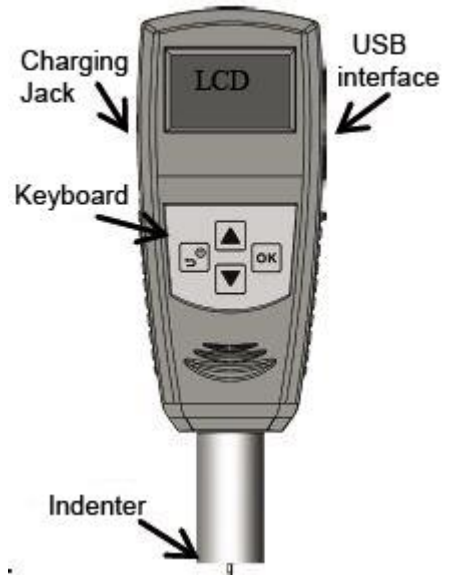

5.2 Keyboard

5.2.1 Power/Return



By pressing this button, the durometer will be power on. By long time pressing this button, the durometer will be power off. By pressing this button, the screen will return to the upper level menu.

5.2.2 OK



Under the measure interface, it will enter the menu interface by pressing this button. Under the menu interface, it will enter the next menu interface. In addition, it is the confirmation button under function selection or parameters setting interface.

5.2.3 UP



Under the menu interface, the selection will be shifted up by pressing this button. Under parameters setting interface, the value will increase by pressing this button.

5.2.4 Down



Under the menu interface, the selection will be shifted down by pressing this button. Under parameters setting interface, the value will decrease by pressing this button. Under some parameters setting interface, the selection will be moved down by pressing this button.

5.3 Interface

The large and high resolution LCD is applied to this durometer, so this durometer has the advantage of fully information display and easy to read etc.

1	Battery level
2	Hardness value
3	Range
4	Average value
5	Test times
6	Current times
7	Test mode: Indicating AVE, Max, MAX AVE



6 Measuring

6.1 Specimen

1. The surface of the specimen shall be flat and parallel over an area to permit the presser foot to contact the specimen over an area having a radius of at least 6 mm from the indenter point.
2. The Specimen shall be suitably supported to provide for positioning and stability.
3. The specimen shall be at least 6 mm in thickness unless it is known that results equivalent to the 6 mm values are obtained with thinner specimen.

The lateral dimensions of the specimen shall be sufficient to permit measurements at least 12 mm from any edge.

6.2 Measure

1. To press the indenter on the surface of specimen and make sure the presser foot is contact closely to it.
2. When data is stable, the buzzer will make a sound and the value will be shown until the next measuring.

Test mode: maximum average value mode
Hardness value measured: 58,1 H
Current statistic times: 5
The measured number: 2
Current average value: 57,8 H
Range: 0,7 H

Multi-point measuring will be realized repeating above steps.

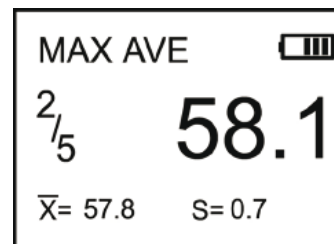





7 Menu

7.1 Menu structure

Menu	Calibration	
	Test Setup	Test mode
		Test times
		Tolerance
		Grubbs error
		Workpiece
		Dwell Time
	System Setup	Date / Time
		Backlight Time
		Key Sound
		Alarm Sound
	Memory	Browse select A to Z
		Browse select Z to A
		Browse select
		Delete All
	Printing Setup	Auto Print
		Print Items
		Print selected
		Print All
	Information	

7.2 Menus operation



In test status, pressing button  to enter menus. When selected a menu item, pressing  to enter. After set up some parameter, pressing  to confirm.

Select menu items. In the digital settings, pressing the  can change the value, pressing the  can change the set item or digital.

Pressing  can return to the previous menu until to the test interface. Or cancel the earlier setup.

7.3 Calibration

The durometer can be calibrated by hard flat plate, standard thickness block or other rubber whose hardness is known.

1. To press indenter on the flat plate, standard thickness block or the rubber whose hardness is known. Keeping the presser foot contact the samples closely for a while to stabilize, the LCD shows the hardness value.
2. Input the theory value (calibration value). If the flat plate is applied, input "100". When standard thickness block is applied, please enter 50. If the rubber is applied, please enter the rubber's hardness.
3. To press  to confirm the calibration. Or to press  to abort the calibration.

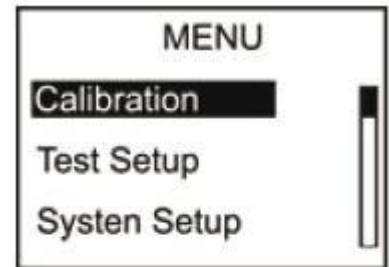

7.4 Test setup

Under Test Setup, Test Mode, Test Times, Tolerance, Grubbs Error, Workpiece, Dwell Time can be set.

7.4.1 Test Mode

There are three kinds of mode: average value mode (AVE), maximum value mode (MAX) and maximum average value mode (MAX-AVE),

1. AVE: During one sampling process, the durometer will record 20 values and calculate the average value of this 20 value automatically. The average value will show on the screen. Under this mode, the statistic time can be set. After one measure process is finished, the durometer will calculate the average value and Range of the data until now automatically. If the statistic time is meet, the last average value will be saved as the measure result.
2. MAX: During one sampling process, the durometer will record 20 values automatically and take the maximum value as the current result. Under this mode, the statistic times can't be set.
3. MAX.AVE: During one sampling process, the durometer will record 20 values automatically and take the maximum value as the current result. Under this mode, the statistic times setting can be set. After one measure process is finished, the durometer will calculate the average value and Range of data until now automatically. The average value of maximum value of every measuring will be calculated and this value will be taken as the last result

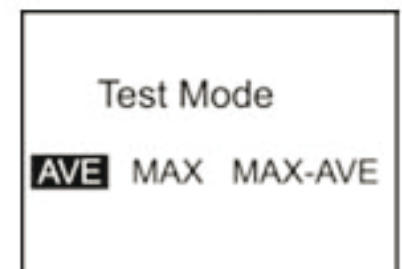
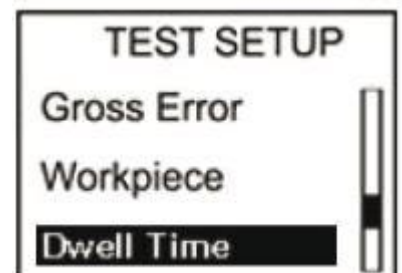
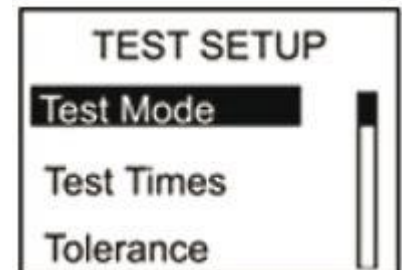

7.4.2 Test Times

The statistic times can be set under this menu. The maximum statistic times setting is 9.



7.4.3 Tolerance

Under this menu, the tolerance limit can be set. When the measuring data is exceed the setting value, the icon of “!” will be showed on the LCD and it will flash. If the alarm function is turn on, the durometer will make the alarm sound.

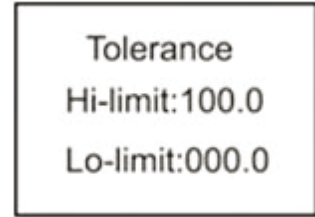

7.4.4 Grubbs error

Under this menu, the Grubbs error handling can be set to on or off. (Grubbs error handling is available only under the average mode and maximum average mode). If the Grubbs error handling function is turn on, the Grubbs error analysis will be applied to the current group when a statistic group is formed (the measure times meet the setting time) and the gross error data will be taken as invalidated data to be abandoned during the calculating of average value and Range. If the auto-print function is turn on, a symbol of “!” will be marked after the gross error data.

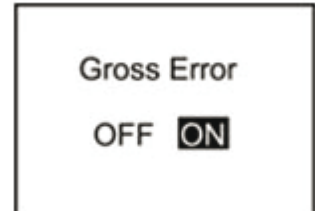

7.4.5 Workpiece

When several samples is need to be measured, the samples can be coded. The coded range is 00 ... 99. When the date saved, the sample code saved too. The samples number corresponding to the data can be printed. It also can be looked up during browsing.

7.4.6 Dwell Time

When Dwell Time is set not “0”, the hardness value is captured for a period of time. This way is specialized by some standards. Now a countdown clock is displayed on LCD.



7.5 System Setup

Under System Setup, the date/time, backlight time, on or off of key sound, on or off of alarm sound can be set.

7.5.1 Date/Time

Under this menu, year, month, day, hour, minute, second can be set.

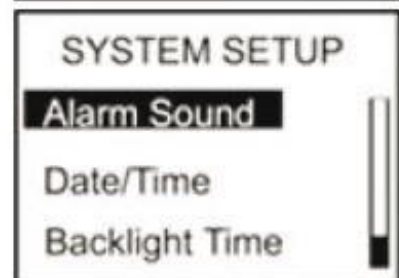
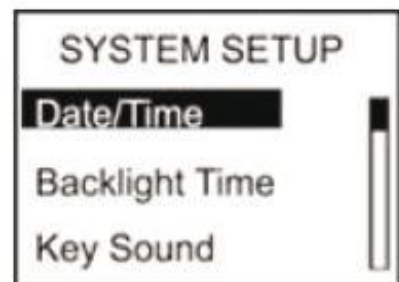
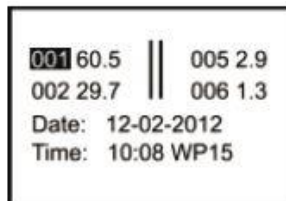

7.5.2 Backlight Time

Under this menu, the continued lighting time of the backlight can be set.

0s: The backlight will be turned off all times.
 15s, 30s, 45s, 60s: The backlight will be turn off when there is no operation for longer than the set.
 Disable: The backlight will light all the time.

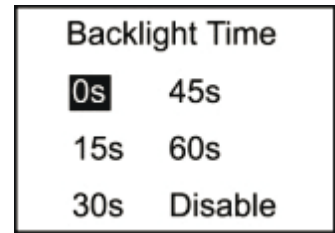

7.5.3 Key Sound

The Key sound can be turn on or off.

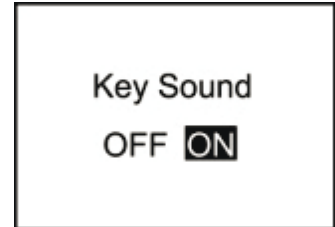

7.5.4 Alarm Sound

If this function is set as on, the duro meter will make a sound of alarm when the data is exceed the tolerance limit.



7.6 Memory

This durometer can storage 500 group data at most (one group data include: one hardness value, the date/time/sample code). If 500 group data have been saved, no more data can be saved, "M Full" will be displayed. You need to delete some or all data for future storage.

7.6.1 Browse A to Z

The first page data will be show when enter this menu (8 data per page). It will turn to the next page by pressing button "▼".

The measure date/time/sample code of the selected data can be show by pressing button "OK".

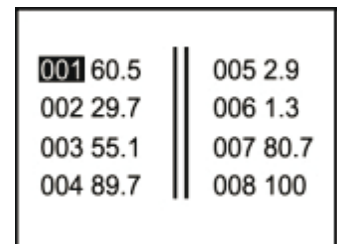

7.6.2 Browse Z to A

The last page data will be show when enter this menu.

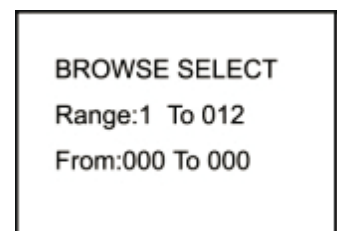

7.6.3 Delete Select

The range of data to be deleted should be setup under this menu.

7.6.4 Delete All

The prompt window will be pushed out under this menu. All data will be deleted by selection of "Yes" and this operation will be aborted by selection of "No".

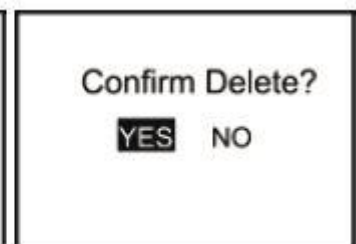

8 Maintain

8.1 Generally

1. This durometer should avoid shock or heavy pressure and can't be exposed to high-intensity magnetic field, high humidity or oil environment.
2. Because the print paper is heat sensitive paper, the paper should avoid high temperature and direct light. If the paper data need to be stored for long time, please make a copy in time.
3. When there are any abnormalities, please don't try to disassemble or adjust any fixed parts. You should fill the warranty card and contact our maintenance department or maintenance agency authorized by our company. Normally, the durometer will not stay in the maintenance department over one week.

8.2 Recharging

The durometer will be recharged by the packaged charger. The durometer will not be auto power on during recharging. The charging status will show in the measuring interface by hand power on. The moving of the battery level icon line indicates it is charging now. If the icon is filled by all line, it means the charging process is finished. If the power is low, the battery level icon will flash to prompt to be recharged in time.

8.3 Reset

Durometer reset: If the software abnormal is happened, the durometer will reset automatically. Hardware reset: The durometer can be reset by the hardware reset under the crash. The reset button is local in the hole of the back shell.

9 Software

9.1 Installation

Start the installation by double-clicking on the file „setup_vXX.exe“ and follow the instructions of the installation wizard.

9.2 File upload

1. Connect the durometer to the PC via the mini USB cable.
2. In the „Control Area“, select the COM port assigned by your PC and assign an index name in the „Condition Area“ to be able to differentiate between several data records.
3. To be able to start the data upload, the upload mode has to be activated. To do so, click on the „Upload Data To PC(U)“ button.
4. Within the durometer menu, navigate to „Memory“, select „Upload Data“. Confirm your selection with the  key on the device.
5. After a few seconds, the data will appear in the software.

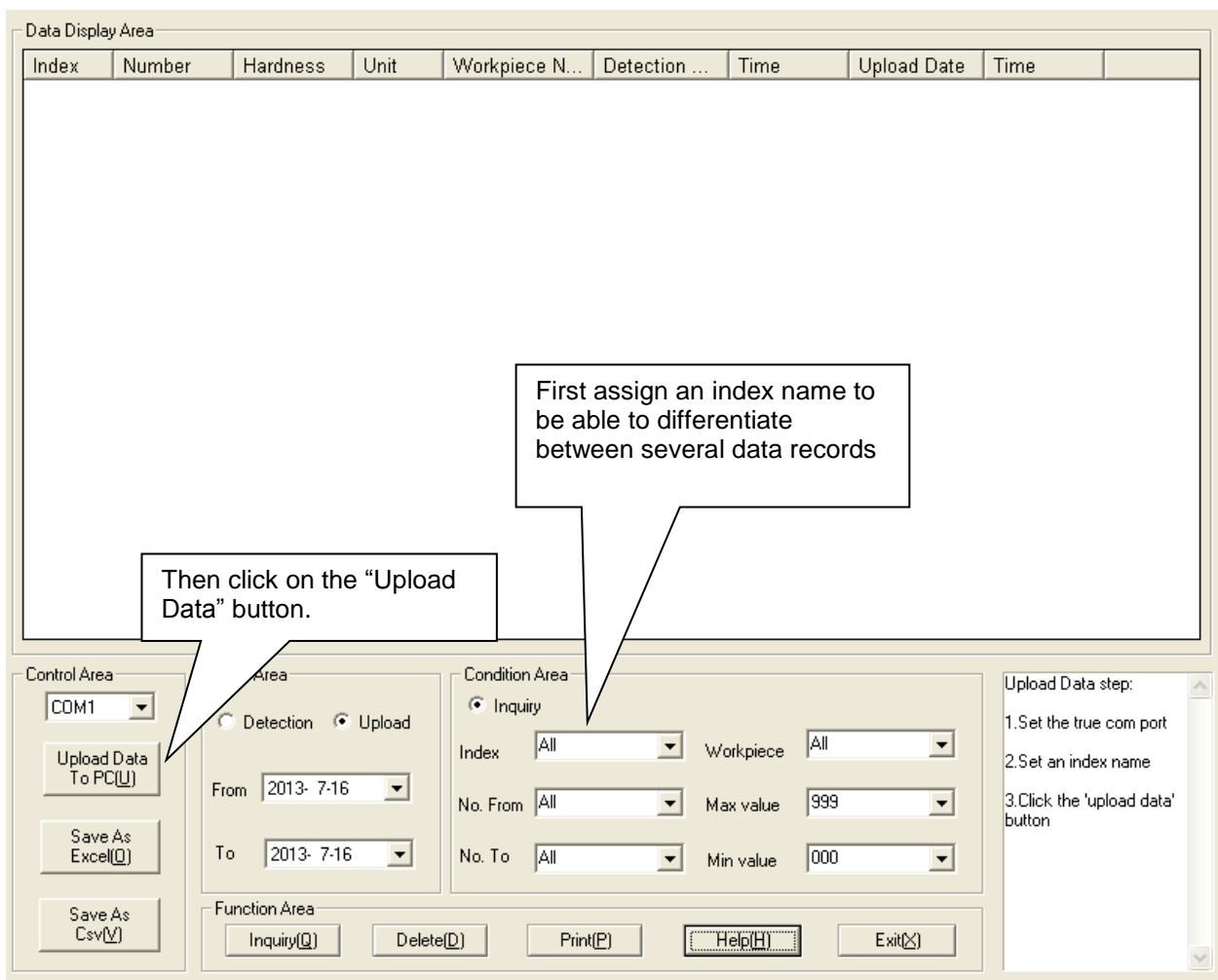

The screenshot shows a software interface with a 'Data Display Area' at the top, which is currently empty. Below it are several control panels: 'Control Area', 'Area', 'Condition Area', and 'Function Area'. A 'Help(H)' button is highlighted with a dashed border. A 'Function Area' contains buttons for 'Inquiry(Q)', 'Delete(D)', 'Print(P)', 'Help(H)', and 'Exit(X)'. On the right, an 'Upload Data step:' list contains three instructions: '1. Set the true com port', '2. Set an index name', and '3. Click the 'upload data' button'. Two callout boxes provide additional instructions: one points to the 'Upload Data To PC(U)' button with the text 'Then click on the "Upload Data" button.', and another points to the 'Index' dropdown in the 'Condition Area' with the text 'First assign an index name to be able to differentiate between several data records'.

Index	Number	Hardness	Unit	Workpiece N...	Detection ...	Time	Upload Date	Time
-------	--------	----------	------	----------------	---------------	------	-------------	------

Control Area

COM1

Upload Data To PC(U)

Save As Excel(Q)

Save As Csv(V)

Area

Detection Upload

From 2013- 7-16

To 2013- 7-16

Condition Area

Inquiry

Index All Workpiece All

No. From All Max value 999

No. To All Min value 000

Function Area

Inquiry(Q) Delete(D) Print(P) Help(H) Exit(X)

Upload Data step:

1. Set the true com port
2. Set an index name
3. Click the 'upload data' button

Then click on the "Upload Data" button.

First assign an index name to be able to differentiate between several data records

9.3 Query and search

1. If you only need the search function, set the needed values in the „Condition Area“ (see image below) and then click on „Inquiry“



The image shows a form titled 'Condition Area' with several dropdown menus. The 'Index' dropdown is set to '44444'. The 'Workpiece' dropdown is set to 'All'. The 'No. From' dropdown is set to 'All'. The 'Max value' dropdown is set to '999'. The 'No. To' dropdown is set to 'All'. The 'Min value' dropdown is set to '000'.

2. In the „Date Area“, you can limit the measured data to a certain date or period. You can select whether you would like to regard the day of measurement („Detection“) or the upload date („Upload“). Select „Detection“ or „Upload“, depending on your requirement and set the start („From“) and end date („To“).



The image shows a form titled 'Date Area' with two radio buttons: 'Detection' (unselected) and 'Upload' (selected). Below the radio buttons are two date dropdown menus. The 'From' dropdown is set to '2009-12-29'. The 'To' dropdown is set to '2009-12-29'.

3. The index name must be assigned manually before each data upload. It helps to differentiate between different data records and makes it easier to search for certain data.
4. Via „No. From“ and „No. To“, you can narrow down how many saved measurements are included in the search.
5. Via „Max value“ and „Min Value“, you can limit your search to a certain range of measurement values.

9.4 Delete data

To delete data, you must first select the data to be deleted from the displayed list. When you have selected all data, click on „Delete“ and confirm the deletion by clicking on „Ok“.

9.5 Print

After limiting the data by clicking on the „Inquiry“ button, you can print all data from the chart by clicking on the „Print“ button.

9.6 Data export



You can export your data (which are in the chart at that time) into a different file format at any time. Two different file formats (Excel or CSV file) can be selected. Click on the corresponding button „Save As ...“ to save the data.

9.7 Close software

To close and exit the software, you can either click on the „Exit“ button or on the „X“ on the upper, right-hand side of the window. A dialogue box will then appear, asking you to confirm.

10 Contact

If you have any questions about our range of products or measuring instruments please contact PCE Instruments.

10.1 PCE Instruments UK

By post:

PCE Instruments UK Ltd.
Units 12/13 Southpoint Business Park
Ensign Way, Southampton
Hampshire

United Kingdom, SO31 4RF

By phone:

02380 987 035

10.2 PCE Americas

By post:

PCE Americas Inc.
711 Commerce Way
Suite 8
Jupiter
33458 FL
USA

By phone:

561 320 9162

